



**INSTITUTO DE CIENCIAS
DE LA CONSTRUCCIÓN
EDUARDO TORROJA**

C/ Serrano Galvache n. 4. 28033 Madrid (Spain)
Tel.: (34) 91 302 04 40 / Fax: (34) 91 302 07 00
direccion.ietcc@csic.es www.ietcc.csic.es



European Technical Assessment

ETA 06/ 0064
of 25/ 05/ 2017

English translation prepared by IETcc. Original version in Spanish language

General Part

Technical Assessment Body issuing the ETA and designated according to Article 29 of the Regulation (EU) Nº305/2011:

Instituto de Ciencias de la Construcción Eduardo Torroja (IETcc)

Trade name of the construction product

POLITABER-FM BICAPA

Product family to which the construction product belongs

Systems of mechanically fastened flexible SBS roof waterproofing membranes.

Manufacturer

ASFALTOS CHOVA, S.A

Ctra. Tavernes – Liria, km. 4.3. 46760
TAVERNES DE LA VALLDIGNA. Valencia, Spain

Manufacturing plant(s)

Tavernes – Liria, km. 4.3
46760 TAVERNES DE LA VALLDIGNA
Valencia, Spain

This European Technical Assessment contains

11 pages including 1 Annexes which form an integral part of this assessment.
Annex 2. Contain confidential information and is not included in the ETA when that assessment is publicly available

This European Technical Assessment is issued in accordance with regulation (EU) No 305/2011, on the basis of

Guideline for European Technical Approval (ETAG) nº 006, used as European Assessment Document (EAD)

This version replaces

ETA 06/0064 issued on 18/ 07/ 2011

Translations of this European Technical Assessment in other languages shall fully correspond to the original issued document and should be identified as such.

Communication of this European Technical Assessment, including transmission by electronic means, shall be in full (excepted the confidential Annex(es) referred to above). However, partial reproduction may be made, with the written consent of the issuing Technical Assessment Body. Any partial reproduction has to be identified as such.

This European Technical Assessment may be withdrawn by the issuing Technical Assessment Body, in particular pursuant to information by the Commission according to Article 25 Paragraph 3 of Regulation (EU) No 305/2011.

SPECIFIC PARTS OF THE EUROPEAN TECHNICAL ASSESSMENT

1 Technical description of the product

POLITABER-FM BICAPA is a multi-layer flexible (SBS (Styrene-butadiene-styrene) modified bitumen) waterproofing roof Kit fastened mechanically with metallic point fasteners to deck structures, with a slope exceeding 1%. The membrane is fastened with metallic point fasteners in area of overlapping at edge of membrane, before it is welded with the following membrane. The Kit is composed of flexible bituminous membranes manufactured by the holder of the approval and mechanical fasteners manufactured by others manufacturers:

Base membrane. POLITABER-POL-PY-30.

Finishing membrane. POLITABER-COMBI-40/G and POLITABER-VEL-40/G.

Mechanical fasteners. Fasteners EVDF/2C with 40 x 40 mm DF-washers by L.R. ETANCO (Annex 1) are used. Other fasteners with CE mark according to European technical approvals based on ETAG 006 are possible but they have to comply with the requirements of the point 5.1.4.1 C of ETAG 006.

The kit supplier is also responsible that only fasteners are used which fulfil the requirements of the AoC procedure. The assessment of this Kit does not include the thermal insulation. The thermal insulation often used with this kit are Panel of mineral wool, of Polyisocyanurate, of polyurethane and Panel of cellulose. The supports often used with this kit are: Corrugated steel plates, corrugated steel of punched or bursted surface, Concrete, Aerated concrete, Wood and wooden boards.

2 Specification of the intended use in accordance with the applicable EAD

The intended use of this product is the waterproofing of roofs with slopes exceeding 1%, preventing the passage of water pass into the interior of the building, both in liquid or vapour form. This assembled system complies with Essential Requirements 2, 3 and 4: Safety in the case of fire, Hygiene, health and environment, and Safety in use, of Regulation 305/2011.

The provisions made in this ETA are based on an assumed intended working life of the assembled system at least of 10 years. The indication given on the assumed intended working life cannot be interpreted as a guarantee given by the manufacturer, but are only to be regarded as a means for choosing the right products in relation to the expected economically reasonable working life of the works.

"Assumed intended working life" means that, when an assessment following the ETAG provisions is made, and when this working life has elapsed, the real working life may be, in normal use conditions, considerably longer without major degradation affecting the Essential Requirements

2. Performance of the product and methods of verification

Assessment of the fitness of the POLITABER-FM BICAPA Kit for the intended use, with regard to Essential Requirements 2, 3 and 4, was performed in compliance with the "Guideline of Systems of mechanically fastened flexible roof waterproofing membranes" (ETAG 006).

The characteristics of this Kit show values, which are within the requirements and tolerances established in the Manufacturer's Technical Dossier (MTD).

This assessment could be extended with other requirements applicable to dangerous substances resulting from transposed European legislation or national regulations and administrative provisions. Moreover, this assessment could be extended with other requirements applicable to the products, resulting from the application of other national regulations and administrative provisions.

Installation. The fitness for use of this system can only be assumed if installation is carried out according to the manufacturer's instructions. It is the responsibility of the manufacturer to guarantee that the information on the application of its products is correctly given to the users. Particularly, it is recommended to consider:

Overlap. The longitudinal and transversal overlap between base membranes must always be 10 ± 1 cm. The longitudinal and transversal overlap between terminal membranes must always be 8 ± 1 cm.

Fasteners. Mechanical fastening of the Systems is carried out on the overlaps, using the aforementioned fasteners, and the washers must be applied at a distance between 2-3 cm from the edge of the membrane, as

indicated in figure 1. Minimum distance between fasteners must be 18 cm, and maximum 36 cm. Maximum distance between rows of fasteners is 90 ± 1 cm.

The number of fasteners per square metre is determined by the varying air pressure on the roof, which depends on the geographic area, area of the roof and height of the building. For the number of fasteners/m² the wind uplift resistance of the fastener and the national regulations and administrative provisions of the member state of destination shall be taken into account.

Intersection at protruding elements. At the intersections with protruding elements (duct for utility installations, etc.) the waterproofing is finished off on a smooth metal profile. This support/profile is anchored mechanically to the fretwork sheet, installed to remain independent of the duct element, which is mechanically fastened to the support deck.

Structural joint. Prior to installation of the membrane and insulation, the structural joint formation profiles must be made available according to the drawing (fig. 2), i.e. plate anchored on one side (flat metal sheet) over the sheet as carrier of the joint insulation, anchoring of the joint formation base profiles (the separation of which will depend on foreseen movement) and insulation of the joint centre, which must be installed prior to closing the second profile.

As reinforcement strip is used POLITABER POL PY 30 membranes (cut to the necessary dimensions) or the strips POLITABER BANDA 33 (0,33 m)

As finished membrane are used POLITABER COMBI 40/G or POLITABER VEL 40/G membranes cut to the necessary dimensions.

Intersection at vertical facing. Intersection at vertical facings is carried out by following the drawing in figure 3.

Gutter catch basins. The installation of the waterproof system is performed with reinforcing membrane POLITABER-POL-PY-30 and with POLITABER-COMBI-40/G or POLITABER-VEL-40/G as finishing membrane (fig.4). In this case, it will ensure the compatibility of the gutter catch basins with the waterproof membranes.

Reinforced areas. In areas with side angles (corners), in the event a greater number of fasteners is required, a reinforcing membrane POLITABER-POL-PY-30 will have to be installed throughout the area, which will allow us to apply one or more rows of fasteners. The new row of fasteners must be situated in the central area of the upper membrane (fig. 5). The main membrane will be welded on the reinforcing membrane

Valley gutters. Valley gutters are carried out following the drawing in figure 6.

Traffic areas. The traffic areas will be correctly protected (light tiles, etc..) to avoid damages in the waterproof membrane.

Use, maintenance and repair of the works. Assessment of the fitness for use is based on the assumption that periodical maintenance of the roof is carried out. Maintenance must include:

- Inspection of the roof at regular intervals.
- Cleaning of downpipes and filters.
- Removal of stones, branches and leaves, etc.
- Inspection of flashing along the edges of the roof, chimneys, drains, skylights, etc.

If the Waterproofing System has been damaged, and is causing leakage, qualified installers must repair it immediately. Maintenance, preservation or remedial work personnel must wear footwear with a suitable sole. Further details are laid down in the MTD located at IETcc.

3 Performance of the product and references to the methods used for its assessment

Assessment of the fitness of this kit for the intended use, with regard to Essential Requirements 2, 3 and 4, was performed in compliance with the "Guideline of Systems of mechanically fastened flexible roof waterproofing membranes" (ETAG 006). The characteristics of this Kit show values, which are within the requirements and tolerances established in the Manufacturer's Technical Dossier (MTD)¹, and which are shown below. This

¹ "The manufacturer's technical dossier (MTD) comprises all information necessary for the production and the processing of the product as well as for the repair of the waterproofing made from that. IETcc checked it and it was found to be in accordance with the conditions stated in the approval and the characteristic value determined during the approval testing.

The part of the MTD to this ETA to be treated confidentially (inter alia the control plan for factory production control and initial type-testing is deposited with IETcc and, as far as this is relevant to the tasks of the notified body involved in the procedure of attestation of conformity shall be handed over to the notified body."

assessment could be extended with other requirements applicable to dangerous substances resulting from transposed European legislation or national regulations and administrative provisions. Moreover, this assessment could be extended with other requirements applicable to the products, resulting from the application of other national regulations and administrative provisions.

3.1 Characteristics of the Kit

The following performances were obtained.

Safety in the case of fire (BWR 2)

External fire performance (EN 13501-5). Classification: B_{roof}(t1). This classification is valid for any support of steel deck (non-perforated) and any continuous support thicker than 10mm with a slope roof <20°.

Hygiene, health and environment (BWR 3)

Release of dangerous substances. According to the manufacture's statement, the product does not contain any dangerous substance according to the EU database.

Safety in use (BWR 4)

Wind uplift resistance. The Kit tested is the constituted by the main membrane, Mineral POLITABER-COMBI-FM-50/G and the fasteners indicated in point 2.4.3. Wadm = 356 N/fastener.

3.2 Membrane Performance

Safety in case of fire (BWR 2)

Reaction to fire. Euroclass F, according to EN 13501.

Hygiene, health and environment (BWR 3)

Performance	Units	Membrane	Standard	Values
R. Tear resistance (nail)	N (L/T)	POLITABER-POL-PY-30	EN 12310-1	185 / 215
Low temperature bending/folding	T°C	All of the system	EN 1109	-20
Watertightness	----		EN 1928	Watertight
Water vapour permeability	μ		EN 1931	20.000
Tensile properties	Tensile strength (N/5cm) (L/T)	POLITABER-POL-PY-30 POLITABER-COMBI-40/G POLITABER-VEL-40/G	EN 12311-1	662 / 410 650 / 476 448 / 284
	Elongation (%) (L/T)	POLITABER-POL-PY-30 POLITABER-COMBI-40/G POLITABER-VEL-40/G		36 / 39 42 / 51 3 / 3
Static loading resistance	kg	All of the system	EN 12730	20
Dynamic loading resistance	mm	All of the system	EN 12691	2000

Safety in use (BWR 4)

Slipperiness. In accordance with item 5.2.4.1 of EOTA 006 Guideline, the bituminous membranes comply satisfactorily with this characteristic and it is not necessary to run the test.

Aspects related to durability and serviceability

Heat exposure resistance (EN 1296). All the membranes are exposed to a temperature of 70 ± 2°C during 168 days, after which the following tests are carried out:

Performance	Direction	Values
Low temperature bending/folding (°C)	Upper face / Down face	- 20

The results obtained show acceptable behaviour of the membranes, as the decrease in peel and shear resistance is less than 20% and the decrease in the resistance to cold bending/folding is below 15°C.

Resistance to UV-radiation in the presence of moisture. In accordance with the EOTA 006 Guideline, it is not necessary to perform this test, as adherence of the mineral granule protection is higher than 70% (EN 12039).

Dimensional stability (EN 1107). - 0.25 %. Results obtained show acceptable behaviour of the membrane, as its dimensional stability is less than 0.6%.

Membrane	% variation
POLITABER-POL-PY-30	- 0,5 %
POLITABER-COMBI-40/G	- 0,2 %
POLITABER-VEL-40/G	0 %

3.3 Performances of mechanical fasteners

Axial load (ETAG 006, 5.3.4.1). According to the ETA 08/0239 of the fastener with the washerr, the value is 1640N.

Unwinding resistance. Apt, according to ETA 08/0239

Aspect of durability, serviceability and identification. The screws and washers show a corrosion resistance of 15 Kesternich cycles.

3.4 Identification of components

Base membrane (POLITABER-POL-PY-30). SBS bitumen-modified reinforcement membrane of 3 Kg/m², with 160 g/m² non-woven polyester felt reinforcement (LBM(SBS)-30-FP).

Finishing membrane

POLITABER-COMBI-40/G. SBS bitumen-modified reinforcement membrane of 4 kg/m², with a mineral finish and 150 g/m² non-woven polyester felt reinforcement thermally stabilised with the insertion of a glass fibre mesh (LBM(SBS)-40/G-FP).

POLITABER-VEL-40/G. SBS bitumen-modified reinforcement membrane of 4 kg/m², with a mineral finish and 60 g/m² reinforcement made up of a glass fibre mesh (LBM(SBS)-40/G-FV).

The main characteristics of this membrane are:

Characteristics	POLITABER-POL-PY-30	POLITABER-COMBI 40/G-FP	POLITABER-VEL-40/G
Reinforcement (g/m ²)	Polyester felt 160 (± 15%)	Polyester felt/glass fibre 150 (±15%)	Glass fibre mesh 60 (± 15%)
Weight (g/m ²)	2800-3300 (average value 3000)	3800– 4300 (average value 4000)	3800-4300 (average value 4000)
Bitumen compound (g/m ²)	2900 (± 10%)	2900 (± 10 %)	2900 (± 10 %)
Protection film (g/m ²)	9	< 12	< 12
Mineral finish (g/m ²)	-----	> 800 (average value 1000)	> 800 (average value 1000)
Nominal thickness (mm)	2.6 (± 10%)	3,2 (±10%)	3,2 (±10%)
Roll dimensions (8 m x 1m)	> 12	> 10	> 10
Roll weight (kg)	34 - 39	38 - 44	38 - 44
Overlap width (mm)	-----	70 - 90	70 - 90

Fasteners. EVDF/2C screw. Double-thread, self-drilling screw, with a diameter of 4,8 mm, lengths of 65-75-90-110-140-180-200-220-240 mm and with a 12-mm diameter flat head. Supracoat 2C-treated zinc-coated steel, with a corrosion resistance of 15 Kesternich cycles.

40 x 40-mm DF washer, with a thickness of 8/10 mm and with a 4.5-mm diameter hole, made of steel with aluminium-zinc alloy (AZ 150) protection, with a corrosion resistance of 15 Kesternich cycles.

4. Assessment and verification of constancy of performance (AVCP) system applied, with reference to its legal base

System of Attestation of Conformity. The European Commission according to the decision (98/143/EC of February 1998, Official Journal of the European Communities No. L 42, 14.02.1998) on the Procedures of Attestation of Conformity (Annex III, clause 2(ii) first possibility of EU Regulation 305/2011) for Systems of mechanically fastened flexible roof waterproofing membranes.

Product	Intended uses	Level or Classes	System
POLITABER-FM BICAPA	Systems of mechanically fastened flexible SBS roof waterproofing membranes	Any	+2

According to this decision, system +2 establishes: *Tasks of the manufacturer:* Factory production control and Initial type-testing of the product and *Tasks of the notified body:* Initial inspection of the factory and production control and Continuous surveillance, assessment and approval of factory production control.

5 Technical details necessary for the implementation of the AVCP system, as provided for the applicable EAD

The ETA is issued for this kit on the basis of agreed data/information, deposited at IETcc, which identifies the product that has been assessed and judged. It is the manufacturer's responsibility to make sure that all those who use the kit are appropriately informed of specific conditions according to sections 1, 2, 4 and 5 including the annexes of this ETA. Changes to the membrane or the components or their production process, which could result in this deposited data/information being incorrect should be notified to the IETcc before the changes are introduced. IETcc will decide whether or not such changes affect the ETA and if so whether further assessment or alterations to the ETA shall be necessary.

5.1 Tasks of the manufacturer

Factory production control. The manufacturer shall exercise permanent internal control of production and ensure that the results obtained comply with the quality level required. All the elements, requirements and provisions adopted by the manufacturer are documented in a systematic manner in the form of written procedures and regulations. This control production system documentation ensures a common understanding of quality assurance and enables the achievement of the required product characteristics according to the ETA.

The manufacturer may only use components stated in the technical documentation of this ETA including Control Plan. The incoming raw materials are subjected to verifications by the manufacturer before acceptance.

The factory production control shall be in accordance with the Control Plan⁽²⁾ which is part of the Technical Documentation of this ETA. The Control Plan has been agreed between the manufacturer and the IETcc and is laid down in the context of the factory production control system operated by the manufacturer and deposited at the IETcc. The results of factory production control shall be recorded and evaluated in accordance with the provisions of the Control Plan.

Initial type-testing of the product. Initial type-testing carried out by the IETcc is that set out in chapter 5 of the guideline for Systems of mechanically fastened flexible roof waterproofing membranes (ETAG 006). The IETcc assessed the results of these tests in accordance with chapter 6 of this Guide, as part of the ETA issuing procedure.

If the verifications underlying this ETA have been furnished on samples from the current production, these will replace the initial type-testing. Otherwise the necessary initial type-testing shall be carried out according to the provisions of the test plan and observance of the required property values shall be ascertained by the notified body. After changing the production process or starting the production in another manufacturing plant the initial type-test shall be repeated.

Other tasks of the manufacturer. Other tasks of manufacturer. The manufacturer shall, on the basis of a contract, involve a body which is notified for the tasks referred to in section 4 in order to undertake the actions laid down in this clause. For this purpose, the control plan shall be handed over by the manufacturer to the notified bodies involved.

For initial type – testing, the results of the tests performed as part of the assessment for the ETA shall be used unless there are changes in the production line or plant. In such cases the necessary initial type- testing has to be agreed with the IETcc.

The manufacturer shall make a declaration of conformity, stating that the construction product is in conformity with the provisions of this ETA

5.2 Tasks of the Notified body

Initial inspection of factory and production control. The notified body ascertains that, in accordance with the MTD, factory conditions and production control allow the manufacturer to ensure the consistency and homogeneity of the manufactured product and its traceability, thus guaranteeing that the final characteristics of the product are those indicated in point 2.

Continuous surveillance, assessment and approval of Factory Production Control. The Notified body shall visit the factory at least twice a year. Surveillance of the manufacturing process shall include:

⁽²⁾ The control plan is a confidential part of this European Technical Assessment and only handed over to the notified body involved in the procedure of attestation of conformity.

- Checking the documentation of factory production control, to ensure continuing compliance with the provisions of the ETA,
- Identification of changes by comparing data obtained during the initial inspection or during the last inspection.

In the event the ETA provisions are not complied with, the certificate of conformity shall be withdrawn.

Issued in Madrid on 25 May 2017.
by



Instituto de Ciencias de la Construcción Eduardo Torroja
CONSEJO SUPERIOR DE INVESTIGACIONES CIENTÍFICAS
c/ Serrano Galvache 4. 28033 Madrid (Spain).
director.ietcc@csic.es www.ietcc.csic.es



On behalf of the Instituto de Ciencias de la Construcción Eduardo Torroja

Marta Mº Castellote
Director

Annex 1.

Essential dimensions of the fasteners

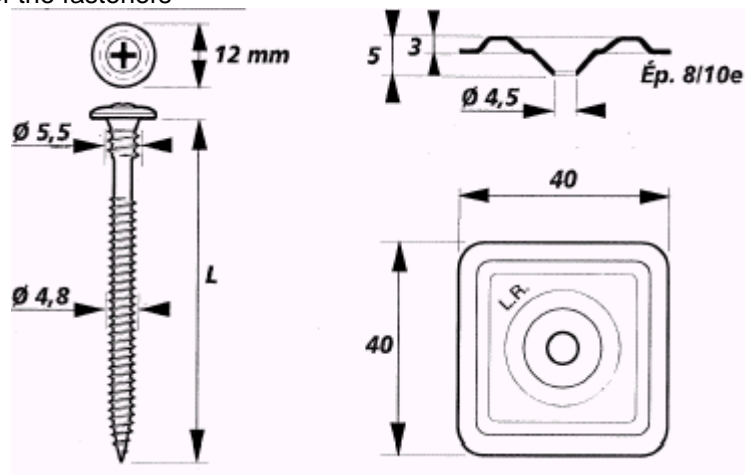

The length (L) of the fastener can be 65, 75, 90, 100, 110, 120, 140, 160, 180, 200, 220 and 240 mm.

The fastener is made by Steel with an anticorrosion coat 2C.

The washer is made by steel with aluminium-zinc alloy protection, 8/10e (mm), 40x40 mm square, with a 4,5-mm diameter hole, with a corrosion resistance of 15 Kesternich cycles.

Fig. 1 Detail of membrane overlap.

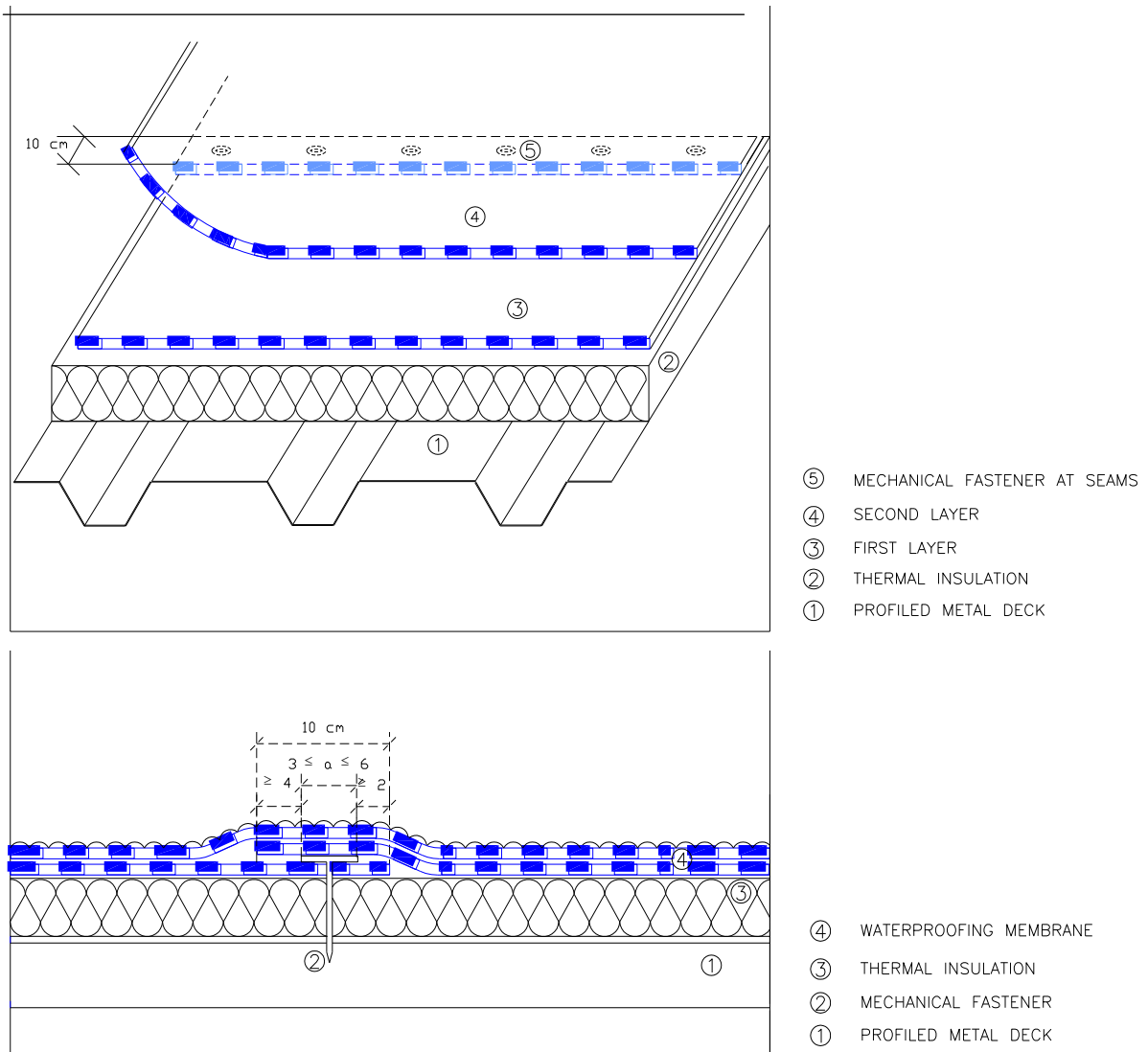

Fig. 2 Detail of a structural joint

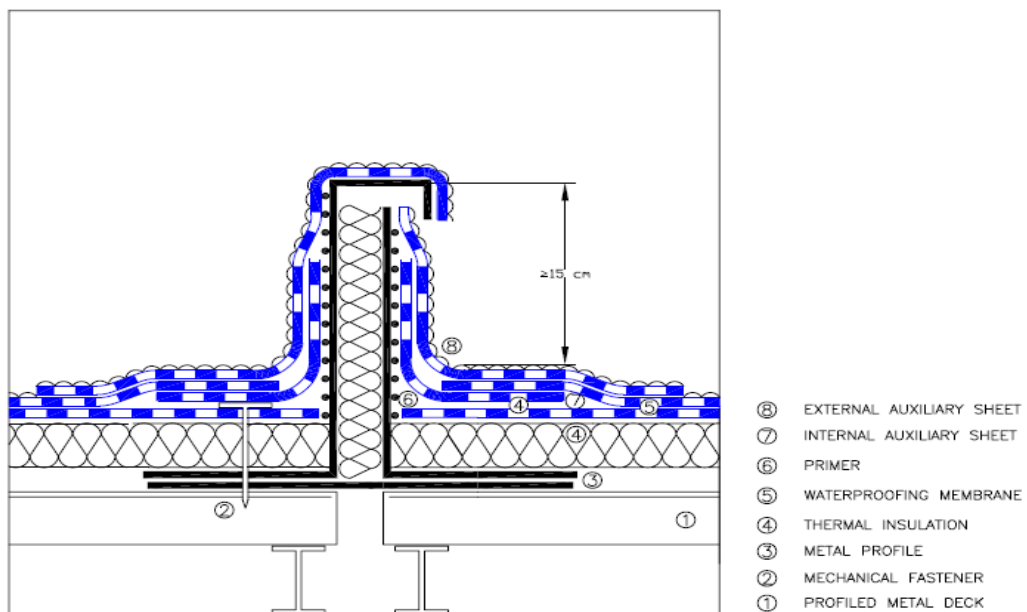

Fig. 3 Insertion with a vertical wall

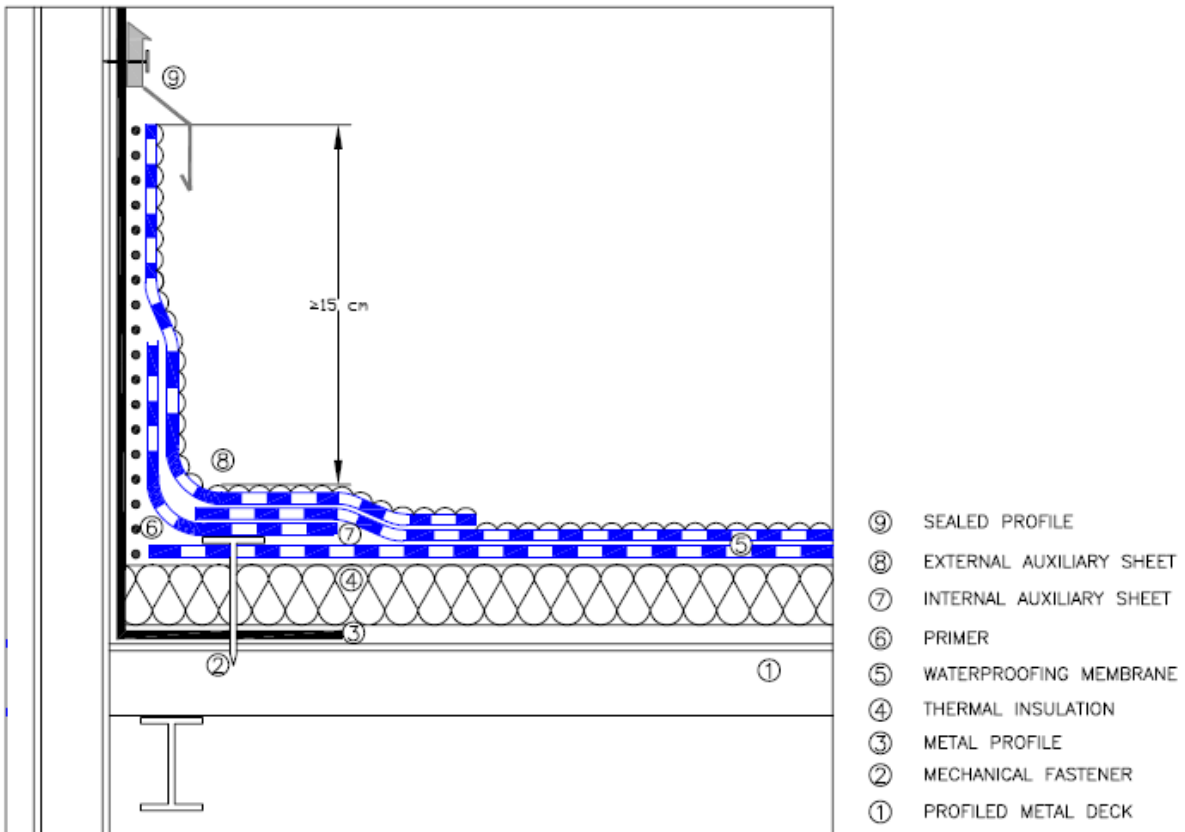

Fig. 4 Drain detail

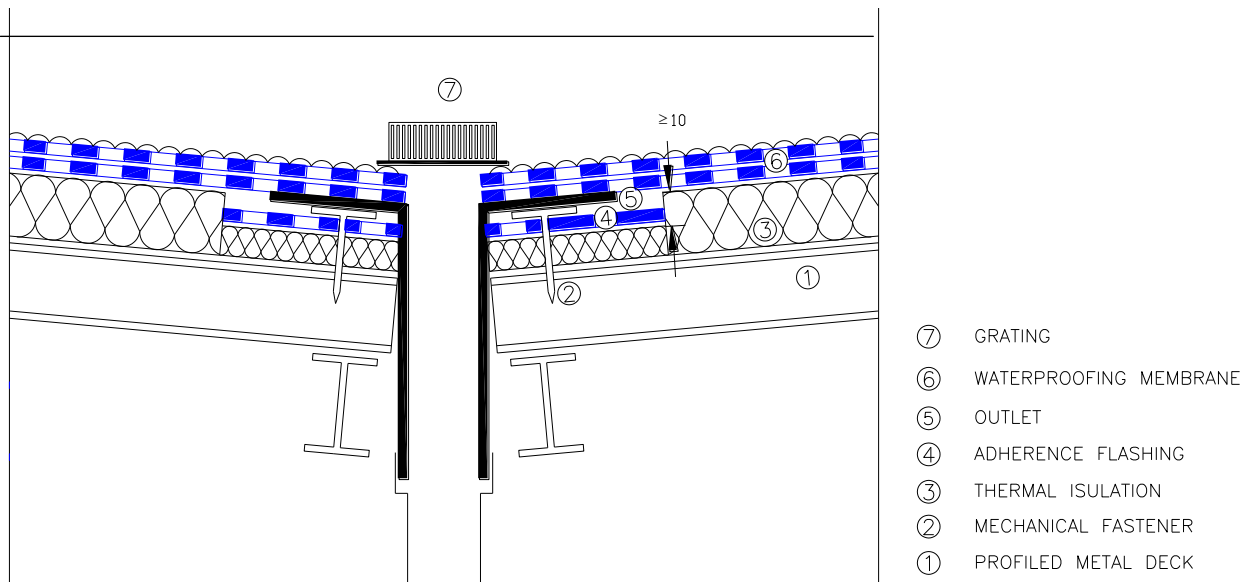

Fig. 5 Corner Detail

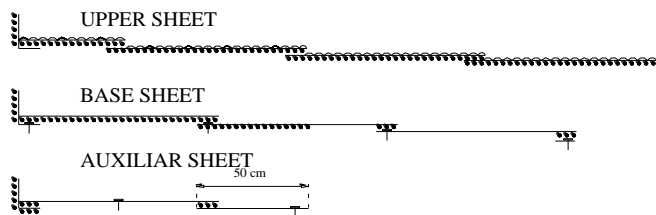
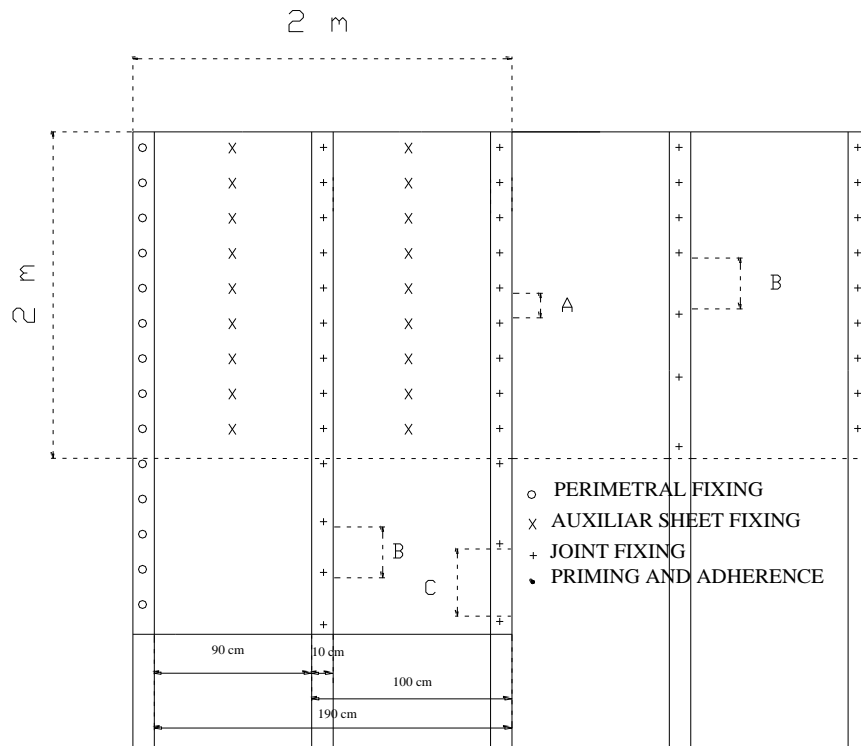

Fig. 6 Reinforcement membrane on valley gutter

