



CHOVAPLAST EXTRA COMBI 50/G

ELASTOMER MODIFIED BITUMEN SHEET.
LBM (SBS). ELASTOMERIC SHEET

TECHNICAL FILE Nº 14190 - REVIEW 6/18 CE
FECHA 02/05/2018

COMPLETE INFORMATION OF CHOVAPLAST EXTRA COMBI 50/G SHEET



View "Declaración de Prestaciones – DoP" in: DoP_E_14190_13707_CHOVAPLASTEXTRACOMBI50G_v02
View CE brand, complete, in: DoP_E_14190_13707_CHOVAPLASTEXTRACOMBI50G_v02

ASFALTOS CHOVA, S.A.

Ctra. Tavernes a Liria, km 4,3. 46760 TAVERNES DE LA VALLDIGNA. Valencia

Sheet description:

Sheet of 1 m x 8 m and 5 kg/m² of plastomers modified bitumen, APP, with polyester nonwoven felt reinforcement, plastic interior trim and slate or mineral granules exterior trim. Place by adhesion with blowtorch. In "Adherents" systems

Recommended for: sheet in monolayer system in the open or topsheet in bilayer systems in the open; monolayer in leaning roof, under tiles.

Not recommended for: lower sheet in bilayer system, landscape roof.

TEST	METHOD	VALUE	UNIT	TOLERANCE
External Fire Performance:	EN 13501-5 : 2002	B _{ROOF} (t1)		
Reaction to fire:	EN 13501-1 : 2002	Class E		
Watertightness:	EN 1928 : 2000	Pass		
Tensile strength in:				
- longitudinal direction:	EN 12311-1 : 1999	700	N / 5 cm	± 200
- transverse direction:		450		± 150
Elongation:				
- longitudinal direction:	EN 12311-1 : 1999	45	%	± 15
- transverse direction:		45		± 15
Root resistance (penetration):	EN 13948 : 2007	PND		
Static loading resistance:	EN 12730 : 2001	≥ 15	kg	
Impact resistance:	EN 12691 : 2006	≥ 1.000	mm	
Tear resistance:	EN 12310-1 : 1999	--		
Joints strength: (to shear)	EN 12317-1 : 1999	450	N / 5 cm	± 150
Durability:	EN 1296 : 1999			
	(Pliability) EN 1109 : 1999	-5	°C	± 5
	(Flow resistance) EN 1110 : 1999	120	°C	± 10
Pliability:	EN 1109 : 1999	≤ -15	°C	
Dangerous substances:	--	PND		

Pass ⇨ Positive or correct; NPD ⇨ No Performance Declared; -- ⇨ Not required

OTHER ADDITIONAL FEATURES OF CHOVAPLAST EXTRA COMBI 50/G SHEET

Designation:	UNE 104410		LBM-50/G-FP	
Visible defects:	EN 1850-1		No visible defects	
Mass per unit area:	EN 1849-1	5,0	kg/m ²	-5 / +10 %
Roll size: (Length x Width)	EN 1848-1	8 x 1	m	≥
Granule loss:	EN 12039	20	%	-20 / +10 %
Dimensional stability:	EN 1107-1	≤ 0,4	%	
Flow resistance:	EN 1110	≥ 120	°C	

www.chova.com

NO REGULATORY INFORMATION. (CE)



**Product with AENOR
brand
(according UNE-EN
13707)**

Provided information corresponds to data obtained in our own laboratories. This product will maintain these characteristics on average. Chova, S.A. reserves the right to modify or cancel any parameter without notice. Chova, S.A. guarantee is only applying to the product quality.

As for commissioning work, which do not participate, they must also meet the waterproofing requirements for the implementation, specified in the applied rules, both in membrane composition and fulfillment them.

This technical data sheet will be void by subsequent revisions and, if in doubt, apply the latest revision.

	<h1>CHOVAPLAST EXTRA COMBI 50/G</h1>
	<p>ELASTOMER MODIFIED BITUMEN SHEET. LBM (SBS). ELASTOMERIC SHEET</p>
	<p>TECHNICAL FILE Nº 14190 - REVIEW 6/18 C€ FECHA 02/05/2018</p>

Reinforcement: **Polyester nonwoven felt, 150 g/m².**

USE RECOMMENDATIONS, ADAPTED TO "CTE", ACCORDING:

- DR del CTE, CEC, "*Constructive Elements Catalogue*", and
- **Norm UNE 104401: 2013, Waterproofing in construction above and below ground, with modified bituminous sheets. Systems and application.**

Depending on the intended use of the roof or treated item, the usual recommended usage possibilities of **CHOVAPLAST EXTRA COMBI 50/G**, sheets are:

FLAT ROOF.

- SINGLE LAYER SHEETS IN HEAVY PROTECTION ROOFS:

CHOVAPLAST EXTRA COMBI 50/G sheet is not recommended for this use.

- BILAYER SHEETS IN HEAVY PROTECTION ROOFS:

CHOVAPLAST EXTRA COMBI 50/G sheet is not recommended for this use.

- TRANSITABLE COVERS FOR VEHICLES:

CHOVAPLAST EXTRA COMBI 50/G sheet is not recommended for this use.

LANDSCAPE ROOF.

- SINGLE LAYER SHEETS IN LANDSCAPE ROOF:

CHOVAPLAST EXTRA COMBI 50/G sheet is not recommended for this use. (No resistant to roots)

- BILAYER SHEETS IN LANDSCAPE ROOF:

CHOVAPLAST EXTRA COMBI 50/G sheet is not recommended for this use. (No resistant to roots)

FLAT ROOFS LIGHT PROTECTION. - (Slope between 1% and 15%)

- SINGLE LAYER SHEETS, IN FLAT ROOFS WITH LIGHT PROTECTION:

The sheet **CHOVAPLAST EXTRA COMBI 50/G** is not recommended for this use.

- BILAYER SHEETS, IN FLAT ROOFS WITH LIGHT PROTECTION:

The **CHOVAPLAST EXTRA COMBI 50 / G** sheet, can be substituted in any of the bilayer membranes provided for the indicated uses, to the base sheets of Type LBM-40 /G, as it is an improvement in performance, increase in mass. In this case, the base sheet will be of type **LBM-30**.

-Non-passable roofs, only accessible to maintenance professionals, installations, etc.

-According to "CEC" solutions, Flat roofs of type: 4.1.6

-According to UNE Standard 104401: 2013, type membrane, MA-NT y BA- NT.

Conditions of the "Non-passable flat roofs with light protection".

The conditions and the application are equivalent to those of covers with heavy protection, except for the exceptions:

- the membrane must always be adhered to the support. (A "non-adhered" solution is not acceptable)

	CHOVAPLAST EXTRA COMBI 50/G
	ELASTOMER MODIFIED BITUMEN SHEET. LBM (SBS). ELASTOMERIC SHEET
	TECHNICAL FILE Nº 14190 - REVIEW 6/18 C€ FECHA 02/05/2018

INSTALATION CONDITIONS OF THE WATERPROOFING SHEETS.

Support conditions for "Passable or Not Passable roofs"

As a support base of waterproofing sheet, concrete, cement mortar, precast concrete, aerated concrete, rock wool plates, expanded clay, lightweight aggregate mortar, etc. can be used.

If the base support is a rigid material, its compressive strength will be equal to 200 kPa (20,000 kg / m²) at least.

If the support base are thermal insulation plates, shall be resistant to welding sheets, or shall apply a protective layer, for example a mortar layer, over the separating layer, being a reinforced mortar. In addition, the support may be the slope layer.

Support preparation. And application conditions

The waterproofing membrane must be adhered to the support. A primer, type SUPERMUL or similar, will be applied previously. Apply a very light layer across the whole waterproofing surface, and according the manufacturer instructions

-Can be applied by brush, paintbrush and spray.

-The application primer temperature must not be less than 5 ° C.

-No primer should be applied when it is raining, snowing or hailing or when it is forecasted that such phenomena are to occur before complete drying.

-Primer drying time will depend on the product type and environmental conditions. (Consult its technical file.)

The sheets should not be applied when the support is wet, when it is raining or when the wind is strong, or when the temperature environment is lower than - 5 °C.

The installation of the waterproofing membrane will be started by executing the following singular points: drains or drains, perimeter reinforcements, corners, expansion joints, etc. (All of them will be "adhered")

In general, for the previous preparations you will be able to consult the "**Manual of waterproofing ...**", of ChovA.

Setting out and placement of sheets layers.

The membrane should preferably be positioned perpendicular to the maximum slope direction line. The different waterproofing layers should be placed in the same direction and flashing.

In each gable, each layer sheets should start to stand by the lowest part of it, and continued until the end of a row, doing overlaps at the joints between pieces. Placing new rows should continue upwardly to the hip line, such that each row overlaps on the previous ones. Overlaps should be in favour of the water stream. The placement of the sheets should be such that no transverse overlap between each row sheets be aligned with any of the adjacent rows.

Single layer sheet.

Slope between 1 % and 15 %.

A layer of sheets making overlaps should be placed between them.

Longitudinal overlaps shall have a nominal width 8 ± 1 cm.

Transverse overlaps shall have a nominal width 10 ± 1 cm.

(See Figure)

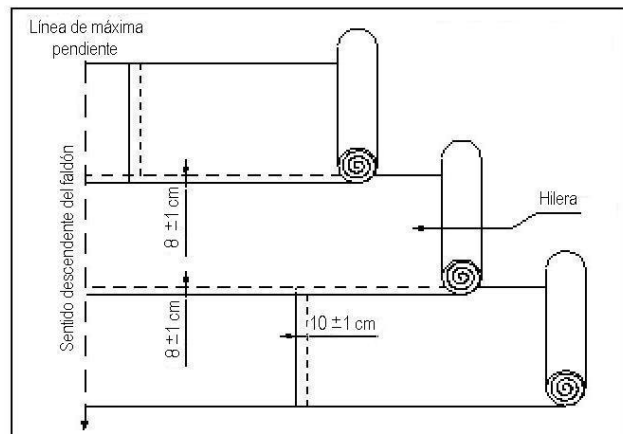

Bilayer sheet.

Slope between 1 % and 15 %.

1st film layer is applied, making the longitudinal and transverse overlapping, which shall have a nominal width of 8 ± 1 cm.

The 2nd layer sheets, always will be applied in the same direction as those of the 1st, and should have their longitudinal overlaps displaced respect to the first, approximately equal to half the width of the sheet.

The longitudinal and transverse overlaps, also must have a nominal width of 8 ± 1 cm. (See Figure)

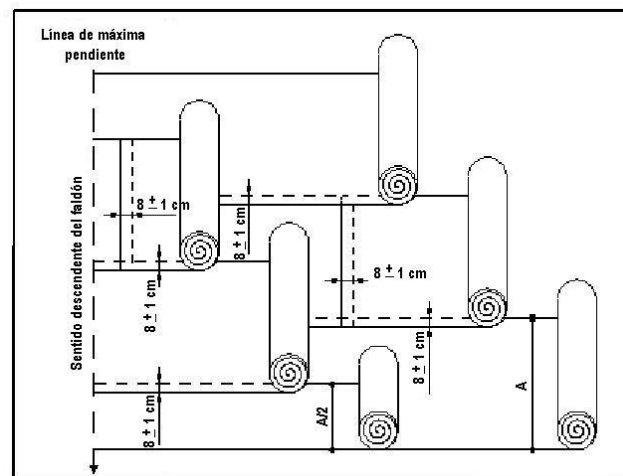

Start. Sheet extending

Single layer sheet.- The first sheet on the cover is extended, starting from the lowest point of the slope. (Avoid, overlaps will meet in the downpipe confluence). Then spread sheets, making the transverse overlaps, to reach the roof perimeter. The following sheet rolls are unwound, placing them parallel to the former. The roll edges of the beginning and end should not coincide with the next. The procedure is repeated, to completely cover the surface to be waterproof.

In the transverse overlaps, with granule, the overlap band will be heated and it will be reworked with the palette to embed granules in the mastic, ensuring the union between the sheets.

Bilayer sheet: In this system, once the 1st layer of sheets has been completed, the 2nd layer sheets, which will be **CHOVAPLAST EXTRA COMBI 50/G** sheet. This should be applied welding it by heating on the 1st layer applied. The sheet is heated using the torch until the nonstick material melts and the mastic is enough softened, while the sheet is unwound and pressed against the support until the molten mastic stands out the edges. And the process is repeated with the following sheets rows.

Finishing materials

	<h1>CHOVAPLAST EXTRA COMBI 50/G</h1>
	<p>ELASTOMER MODIFIED BITUMEN SHEET. LBM (SBS). ELASTOMERIC SHEET</p>
	<p>TECHNICAL FILE Nº 14190 - REVIEW 6/18 C € FECHA 02/05/2018</p>

When sheet applied to the entire roof surface, will be finished with embedding in faces according to the planned solution.

It may refer to the "**Waterproofing manual...**" by ChovA, to see the different types of finish.

SLOPING ROOF.- (Slopes higher than 15%)

Single layer self-protected system. (Continuous system)

CHOVAPLAST EXTRA COMBI 50/G sheet is not recommended for this use.

Bilayer self-protected system. (Continuous system)

The application of bilayer membranes with these slopes is not recommended, although they are admissible.

Monolayer system with heavy protection. (Finished with discontinuous elements)

The covers are designed to evacuate the water with the help of the slope and finished with discontinuous coverage elements (tiles, light alloy plates, slate or bituminous plate - **Tegola Americana**).

CHOVAPLAST EXTRA COMBI 50/G sheet is recommended only in case of monolayer membrane under: roof tile or other discontinuous covering. With battens, inverted cover, etc. Also under Tegola Americana, bituminous plate.

- **NOT PASSABLE roofs**, with tiles or other discontinuous element protection, on battens, etc. According "CEC" solutions. Roof type: 4.1.9, 4.1.11 and 4.1.12
- According to UNE 104401: 2013, norm, sheet type, MC-TE, MI-TE and BC-PB.

Support conditions in "Sloping roofs".

As a base support of the waterproofing sheet, concrete, cement mortar, wood or ceramic board, thermal insulation boards, etc. can be used. If the base support plates are thermal insulation, shall be resistant to welding sheets, or to apply a protective layer, for example a layer of mortar, this being reinforced.

The waterproofing sheet be mechanically attached or adhered to the support. In adhered systems, previously apply a primer, **SUPERMUL** type or similar. A single and very light layer will apply. It does not apply when using welded insulation boards, **LAROC S**.

In the case of an inverted roof, insulation boards shall be extruded polystyrene, XPS, **ChovAFOAM 300**. The finish of the panels will be smooth upper surface, with tiles on battens, or grooved finish with mortared tiles.

If you step on the membrane, on the movements, you should take the necessary safety measures to prevent falls.

Sloping roof way of placement

It will be carried as provided in flat roof, with the following conditions:

- The sheet rows are placed in the slope direction;
- The application starts, preferably from the edge corresponding to prevailing winds;
- The sheet must always be adhered;
- For slopes between 15% and 40% also will fix mechanically in the transverse overlaps and the distance between adjacent fastener will be 30 cm high, and will be located approximately at half the width of the overlap band and 4 cm at least the edge of the sheet

Single layer sheet.

Slope between 15 % and 50 %.

A layer of sheets making overlaps should be placed between them.

Longitudinal overlaps shall have a nominal width 8 ± 1 cm.

Transverse overlaps shall have a nominal width 10 ± 1 cm.

Mechanical fixings in the transverse overlap.

Slope higher than 50 %.

Note.- In addition, lateral fixations will be applied, in the longitudinal overlaps. (See Figure).

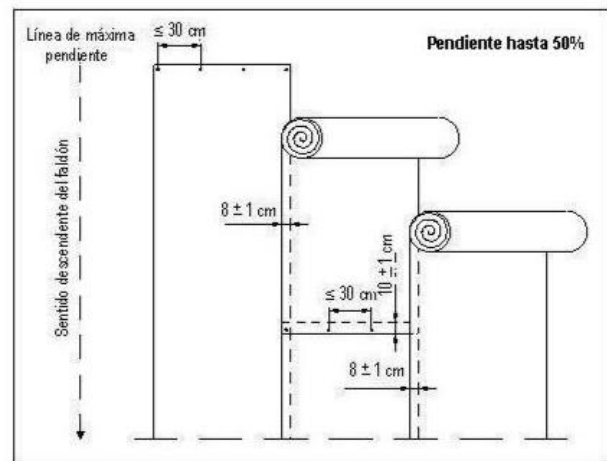

It must also be considered:

- at the ridge and overlaps, in addition to adhering, the sheet must be fixed mechanically;
- when the upper end of the sheet lift a facing, it must also be fixed mechanically;
- between the nail and the edge of the sheet must be a distance of 4 cm or more.
- the attachments must penetrate the resistant support 15 mm, at least depending on its nature and consistency.

Overlaps adherence will be performed welding by heating. A review will be done, by heating the overlap edge and sealing it with the trowel.

WALLS AND FOUNDATIONS

Treatment in walls and foundations has some requirements depending on the ground groundwater level and the depth of the foundation. Check conditions and requirements.

CHOVAPLAST EXTRA COMBI 50/G sheet is recommended as single layer sheet or bilayer constituent, for improvement, where provided. Depending on the groundwater level, regarding the foundation.

The sheet application to form the membrane was adjusted to casuistry flat roof, in foundations, and sloping roof, - it really is in the vertical- in walls. In this case sheets shall be applied in the bottom-up direction and always adhered. (In addition, in general, No mechanical fastening is required).

For considerable height walls, in application conditions, always prevail safety requirements at work, at the expense of applying smaller size pieces compared to the full rolls application. But, ensuring good adhesion to the wall and the effective overlaps sealing.

Always, if in doubt, consult in advance with the Technical Department **ChovA, S. A**

	<h1>CHOVAPLAST EXTRA</h1> <h2>COMBI 50/G</h2>
	<p>ELASTOMER MODIFIED BITUMEN SHEET. LBM (SBS). ELASTOMERIC SHEET</p>
	<p>TECHNICAL FILE Nº 14190 - REVIEW 6/18 C€ FECHA 02/05/2018</p>

GENERAL. COMPLETION SHEET WORK.

- On the roof, keep the rolls standing, to implementation, in the original pallet, not stacking pallets on top of other.
- Waterproofing work should not be performed when weather conditions may be harmful, especially when it is snowing or there is snow or ice on the roof, when its raining or the roof is wet, or when strong winds blow. Neither work should be performed when the ambient temperature is less than:
 - a) + 5 ° C when water-based emulsions are used;
 - b) - 5 ° C when modified bitumen sheets are used.
- It should have a flat without ridges, clean and dry properly uniform surface.
- You always have to make the sealing of the membrane at the end of the day, and especially if rain threatens.
- A tightness test shall do once finished membrane. It was recommend:
 - Flat roof, root flood for at least 24 h. and at most about 48 hours. (In case of rain risk, the test should be postponed to avoid overloads on the cover).
 - In sloped roof, irrigation cover for at least 48 h and a maximum of about 72 h.
- Flashings should be placed before applying the protection, on the expansion joint. If it's raised, they should be protected adequately.
- The store of protective materials, should be done in response to avoid damaging the sheet, and distributed avoiding overloads. No objects shall deposit over the membrane, such as drums, planks, pickaxes, shovels, etc., which may deteriorate
- During the application, shall be avoided perform actions on the sheet that may damage it, such as cutting tile, insulation panels, etc., taking necessary precautions if necessary.
- The protection elements must be placed with joints between them, to allow the passage of water and the free expansion of materials.
- Do not apply sheet products not compatible, e.g. projected polyurethane.
- We should make a subsequent maintenance of the deck, in the periods specified in the legislation or in the CTE.

SECURITY CONDITIONS.

Regarding the safety and health during the execution of the works, shall apply the provisions of legislation in relation to the Prevention of Occupational Risks.

Personnel performing the waterproofing system should know the risks involved in its implementation and the correct method of placing the roof units, all within the overall regulatory framework for health and safety that is required the general contractor of the work.

All the solutions above indicated, the conditions of application and comments are set to:

- DR CTE, CEC, "**Constructive Elements Catalog**" and
- UNE 104401: 2013, "**Waterproofing in the above and below ground building, with modified bituminous sheets. Systems and application.**"(AENOR Document)

The bituminous sheet is a component of the waterproofing membrane. Waterproofing solutions are the responsibility of the project, although the included information is intended to describe the usual conditions of product use. As for commissioning

	CHOVAPLAST EXTRA COMBI 50/G
	ELASTOMER MODIFIED BITUMEN SHEET. LBM (SBS). ELASTOMERIC SHEET
	TECHNICAL FILE Nº 14190 - REVIEW 6/18 CE FECHA 02/05/2018

work, also must satisfy the requirements of waterproofing implementing specified in the rules. The information provided is taken from the current regulations.