

COMPLETE INFORMATION OF POLITABER POL PY 40 SHEET



View "Declaración de Prestaciones – DoP" in: DoP_E_32155_13707_POLITABERPOLPY40_v02

View CE brand, complete, in: DoP_E_32155_13707_POLITABERPOLPY40_v02

ASFALTOS CHOVA, S.A.

Ctra. Tavernes a Liria, km 4,3. 46760 TAVERNES DE LA VALLDIGNA. Valencia

Sheet description:

Sheet of 1 m x 10 m and 4 kg/m² of elastomers modified bitumen, with polyester nonwoven felt armor, plastic interior and exterior trim. Place by adhesion by blowtorch. In "Adherents" or "No Adherents" systems to support.

Uses by: UNE-EN 13707, 13859-1, 13969 y 13970

Recommended for: According to regulations of the country of use.

Not recommended for: sheet out in the open; upper sheet in landscape roofs..

TEST	METHOD	VALUE	UNIT	TOLERANCE
External Fire Performance:	EN 13501-5 : 2002	B _{ROOF} (t1)	Documentation of A. Chova, Verified by AENOR	
Reaction to fire:	EN 13501-1 : 2002	Class E		
Watertightness:	EN 1928 : 2000	Pass		
Tensile strength in:				
- longitudinal direction:	EN 12311-1 : 1999	700	N / 5 cm	± 200
- transverse direction:		450		± 150
Elongation:				
- longitudinal:	EN 12311-1 : 1999	45	%	± 15
- transverse:		45		± 15
Root resistance (penetration):	EN 13948 : 2007	PND		
Static loading resistance:	EN 12730 : 2001	≥ 15	kg	
Impact resistance:	EN 12691 : 2006	≥ 1.000	mm	
Tear resistance:	EN 12310-1 : 1999	--		
Joints strength: (to shear)	EN 12317-1 : 1999	450	N / 5 cm	
Durability:	EN 1296 : 1999			
(Pliability)	EN 1109 : 1999	--		
(Flow resistance)	EN 1110 : 1999	--		
Pliability:	EN 1109 : 1999	≤ -15	°C	
Dangerous substances:	--	PND		

Pass ⇨ Positive or correct; NPD ⇨ No Performance Declared; -- ⇨ Not required

OTHER ADDITIONAL FEATURES OF POLITABER POL PY 40 SHEET

Designation:	UNE 104410		LBM-40-FP	
Visible defects:	EN 1850-1		No visible defects	
Mass per unit area:	EN 1849-1	4,0	kg/m ²	-5 / +10 %
Roll size: (Length x Width)	EN 1848-1	10 x 1	m	≥
Granule loss:	EN 12039	--	%	
Dimensional stability:	EN 1107-1	≤ 0,6	%	
Flow resistance:	EN 1110	≥ 100	°C	
Mass pliability at a low temperature:	EN 1109	≤ -20	°C	

www.chova.com

NO REGULATORY INFORMATION. (CE)

 <p>Product with AENOR brand (according UNE-EN 13707)</p>	<p>Provided information corresponds to data obtained in our own laboratories. This product will maintain these characteristics on average. ChovA, S.A. reserves the right to modify or cancel any parameter without notice. ChovA, S.A guarantee is only applying to the product quality. As for commissioning work, which do not participate, they must also meet the waterproofing requirements for the implementation, specified in the applied rules, both in membrane composition and fulfillment them. This technical data sheet will be void by subsequent revisions and, if in doubt, apply the latest revision.</p>
--	--



ChovA
SISTEMAS DE IMPERMEABILIZACIÓN
Y AISLAMIENTO

POLITABER POL PY 40

ELASTOMER MODIFIED BITUMEN SHEET.
LBM (SBS). ELASTOMERIC SHEET

TECHNICAL FILE Nº 32155 - REVIEW 8/16 C€
FECHA 16/04/2018

DESCRIPTION OF POLITABER POL PY 40 SHEET



4. Plastic Film. Nonstick
3. Polyester nonwoven felt, type 160 g/m²
2. POLITABER – SBS elastomer bitumen
1. Plastic Film. Nonstick

USE RECOMMENDATIONS, ADAPTED TO “CTE”, ACCORDING:

- DR del CTE, CEC, “*Constructive Elements Catalogue*”, and
- Norm UNE 104401: 2013, **Waterproofing in construction above and below ground, with modified bituminous sheets. Systems and application.**
- DIT Nº 578R/15: “POLITABER ZERO SLOPE”.

Depending on the intended use of the roof or treated item, the usual recommended usage possibilities of **POLITABER POL PY 40**, sheets are:

FLAT ROOF .-(Slopes between 1 and 5%)

- SINGLE LAYER SHEETS IN HEAVY PROTECTION ROOFS:

- PASSABLE ROOF FOR PEDESTRIANS, designed to support the restricted transit of pedestrians.
- PASSABLE ROOF FOR PUBLIC AND SPORTS USE, foreseen for the intensive transit of public use of pedestrians and, eventually, of vehicles. (For this application the system should be adhered);
- According to “CEC” solutions, covers types: 4.1.1, 4.1.2, 4.1.3 and 4.1.4
- According to UNE Standard 104401: 2013, membrane types: MC-TP, MI-TP, MC-TI and MI-TI.

The roof can be finished with: tiles, received with mortar; tiles, supported on supports (plots); filtering and insulating slabs, with XPS, **INVERLOSA**, as invertible visitable cover; mortar layer; or others, according to design. (Pedestrian)

The cover can be finished with: natural stone or hydraulic tile, received with mortar; cobble or wooden strip, on sand bed; concrete or filter mortars; agglomerated asphalt; sports pavements; or others, according to design. (Public use)

-NOT PASSABLE roofs, accessible only to roof maintenance professionals, systems, etc.

According solutions in “CEC”, type. Roof type: 4.1.5

According to UNE 104401: 2013 standard, membrane types MC-NT y MI-NT

The roof can be finished with: gravel; loose slabs; light plates; or others, according to design.

Depending on the position of the insulation with respect to the membrane, it can be:

- CONVENTIONAL ROOF. Resistant support, insulation and base support, and over it the membrane.
- INVERTED ROOF . The membrane, separating layer, and insulation, which should be **XPS** type, polystyrene extruded, **ChovAFOAM 300 M**, of adequate thickness according to **DB-HE**, or with application of porous slabs, **INVERLOSA**, that include XPS insulation.

Note.- In all cases, the separation / anti-puncture layers defined in the “CEC-CTE” must be included.

On an inverted roof, between the insulation, and a layer of tiles received with mortar, a separating / draining layer, must be applied, to ensure non-adhesion.

	POLITABER POL PY 40
	ELASTOMER MODIFIED BITUMEN SHEET. LBM (SBS). ELASTOMERIC SHEET
	TECHNICAL FILE Nº 32155 - REVIEW 8/16 C€ FECHA 16/04/2018

- **TRANSITABLE COVERS FOR VEHICLES:** the conditions of these membranes and their usage, it is recommended to refer to the specific sections of the "Manual of waterproofing ...", of ChovA, or consult the Technical Department of ChovA, S. A.

- BILAYER SHEETS IN HEAVY PROTECTION ROOFS:

Recommended use. Bilayer membrane covers with slopes: between **1% and 5% or 0% (According to DIT Nº 578R/15)**. **POLITABER POL PY 40** sheet, can be substituted, in any of the two-layer membranes provided for the indicated uses, to the sheets of Type LBM-30, for being an improvement of benefits, increase of mass.

FLAT ROOF.- (Slopes between 5 and 15%)

The above solutions are valid, except for the exceptions:

- the membrane must always be **ADHERED** to the support;
- will not be accepted as heavy protection: neither gravel nor any other finish whose stability and functionality it is not guaranteed in the indicated slope range.

LANDSCAPE ROOF.- (Slopes between **1% and 5% or 0% according to DIT**)

- SINGLE LAYER SHEETS IN LANDSCAPE ROOF:

POLITABER POL PY 40 sheet is not recommended for this use. (No resistant to roots)

- BILAYER SHEETS IN LANDSCAPE ROOF:

POLITABER POL PY 40 sheet is recommended for this use, as a bottom layer under **POLITABER GARDEN COMBI**. (Adhered system)

According to "CEC" solutions, Cover of type: 4.1.7

According to UNE Standard 104401: 2013, membranes of the types: BC-AJ and BI-AJ.

According to **DIT Nº 578R/15: "POLITABER ZERO slope"**, as base sheet.

Over the membrane or the insulation layer, according to design, it will be applied: A / separating layer; B / draining or water retaining layer (Use the appropriate type of ChovADREN); C / filter layer and small particles retainer; D / soil of adequate thickness

Depending on the position of the insulation with respect to the membrane, it can be:

- **CONVENTIONAL.** Resistant support, insulation and base support, and on it the membrane.
- **INVERTED.** The membrane, separating layer, and insulation, which should be **XPS** type, polystyrene extruded, **ChovAFOAM 300 M**, of adequate thickness according to the **DB-HE**.

Note.- In all cases, the separation / anti-puncture layers defined in the "**CEC-CTE**" must be included.

	POLITABER POL PY 40
	ELASTOMER MODIFIED BITUMEN SHEET. LBM (SBS). ELASTOMERIC SHEET
	TECHNICAL FILE Nº 32155 - REVIEW 8/16 C€ FECHA 16/04/2018

INSTALATION CONDITIONS OF THE WATERPROOFING SHEETS. FOR FLAT ROOFS (SLOPES 1 TO 5%)

Support conditions for "Passable or Not Passable roofs"

As a support base of waterproofing sheet, concrete, cement mortar, precast concrete, aerated concrete, rock wool plates, expanded clay, lightweight aggregate mortar, etc. can be used.

If the base support is a rigid material, its compressive strength will be equal to 200 kPa (20,000 kg / m²) at least.

If the support base are thermal insulation plates, shall be resistant to welding sheets, or shall apply a protective layer, for example a mortar layer, over the separating layer, being a reinforced mortar. In addition, the support may be the slope layer.

Support preparation. And application conditions

The waterproofing membrane may be "adhered" or "not adhered" to the support, depending on the specific system. (In not-adhered systems, optionally a separating and / or anti-puncture layer can be arranged between the support and the membrane).

In adhered systems, previously, a primer, SUPERMUL kind or similar shall be applied. It'll be applied a only and very light layer will be applied across the hole waterproofing surface, and according the manufacturer instructions:

-Can be applied by brush, paintbrush and spray. One layer with a yield between 150 – 250 g/m²

-The application primer temperature must not be less than 5 ° C.

-No primer should be applied when it is raining, snowing or hailing or when it is forecasted that such phenomena are to occur before complete drying.

-Primer drying time will depend on the product type and environmental conditions. (Consult its technical file.)

- **Non-adherent systems.** All singular points will be primed.

- **Adhered systems.** The entire surface to be waterproofed will be primed.

The sheets should not be applied when the support is wet, when it is raining or when the wind is strong, or when the temperature environment is lower than - 5 °C.

The installation of the waterproofing membrane will be started by executing the following singular points: drains or drains, perimeter reinforcements, corners, expansion joints, etc. (All of them will be "adhered")

In general, for the previous preparations you will be able to consult the "**Manual of waterproofing ...**", of ChovA.

Setting out and placement of sheets layers.

The membrane should preferably be positioned perpendicular to the maximum slope direction line. The different waterproofing layers should be placed in the same direction and flashing.

In each gable, each layer sheets should start to stand by the lowest part of it, and continued until the end of a row, doing overlaps at the joints between pieces. Placing new rows should continue upwardly to the hip line, such that each row overlaps on the previous ones. Overlaps should be in favour of the water stream. The placement of the sheets should be such that no transverse overlap between each row sheets be aligned with any of the adjacent rows.

The waterproofing membrane may be adhered or not adhered to the support. In adhered systems, a previously applied primer, type SUPERMUL or similar. It will apply a single layer and very light. In non-adhered systems, optionally, a separating and / or anti puncturing layer may be provided.

Single layer sheets.

Single layer sheet.

slope between 1 % and 5 %.

A layer of sheets must be placed making the overlaps between them.

Longitudinal overlaps shall have a nominal width of 8 ± 1 cm.
Transverse overlaps shall have a nominal width of 10 ± 1 cm.
(See Figure).

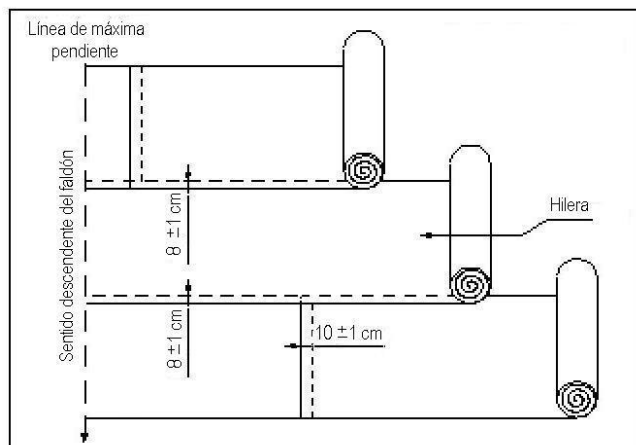

Start. Sheet extending

The first sheet on the cover is extended starting from the lowest point of the slope. (Avoid, overlaps will meet in the downpipe confluence). Then spread sheets, making the transverse overlaps, to reach the roof perimeter. The following sheet rolls are unwound, placing them parallel to the former. The roll edges of the beginning and end should not coincide with the next. The procedure is repeated, to completely cover the surface to be waterproof.

System not adhered.

The sheets must adhere to each other in the overlaps and the support at all singular points. The edges of the sheets are heated, with the help of the torch until the non-stick material is melted and the sheet mastic is sufficiently softened, and is it pressed until the molten mastic protrudes from the edges. And the process is repeated with the following rows of sheets.

The "non-adhered" systems will be admissible for covers whose intended use is: "Non-passable" or "Private pedestrian passable".

Adhered system.

The sheet must be applied by welding it by heating it on the primer of the base. The sheet is heated with the help of a blowtorch until the non-stick material is melted and the sheet mastic is sufficiently softened, at the same time unwinding the sheet and pressing it against the support until the molten mastic protrudes from the edges. And the process is repeated with the following rows of sheets.

The "adhered" systems will be obligatory for the rest of the uses, and admissible for the previous uses.

Sheet finishing.

When sheet applied to the entire roof surface, will be finished with embedding in faces according to the planned solution. It may refer to the "**Waterproofing manual...**" by **ChovA**, to see the different types of finish

Bilayer sheets.

Start. Sheet extending

In this system, once the 1st layer of sheets has been completed. The 2nd layer sheets, which will be the **POLITABER POL PY 40**. This should be applied welding it by heating on the 1st layer applied. The sheet is heated using the torch until the nonstick material melts and the mastic is enough softened, while the sheet is unwound and pressed against the support until the molten mastic stands out the edges. And the process is repeated with the following sheets rows. (See Figure)

Bilayer sheet.

0% slope and slope between 1 % and 5 %.

1st film layer is applied, making the longitudinal and transverse overlapping, which shall have a nominal width of 8 ± 1 cm.

The 2nd layer sheets, always will be applied in the same direction as those of the 1st, and should have their longitudinal overlaps displaced respect to the first, approximately equal to half the width of the sheet.

The longitudinal and transverse overlaps, also must have a nominal width of 8 ± 1 cm. (See Figure)

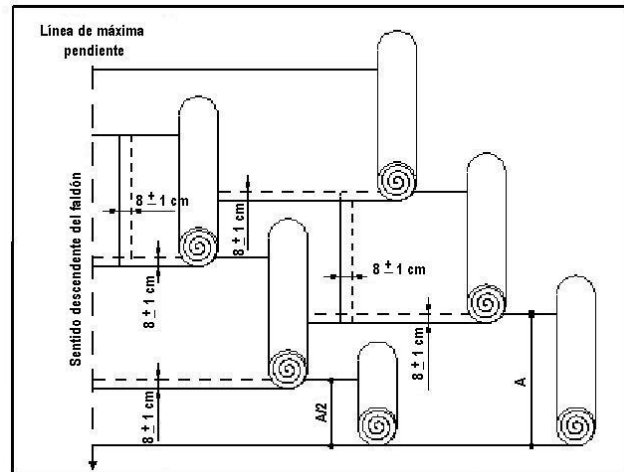

Finishing materials

A separating and / or anti-puncturing layer and the finishing layers foreseen in the project will be applied on the membrane.

In the case of an inverted roof, a separating geotextile will be applied over the membrane and the extruded polystyrene panels, XPS, ChovAFOAM 300 M thick expected. And on these, the separating and / or anti-puncture layer and the finishing layers. (Do not apply layers of polyurethane sprayed on the sheet, or other materials not provided for in the CTE, nor in applicable documents or standards, for the installation).

FLAT ROOFS LIGHT PROTECTION. - (Pending between 1% and 15%)

- SINGLE LAYER SHEETS, IN FLAT ROOFS WITH LIGHT PROTECTION:

The sheet **POLITABER POL PY 40** is not recommended for this use. (Not suitable to be exposed to the weather)

- BILAYER SHEETS, IN FLAT ROOFS WITH LIGHT PROTECTION:

POLITABER POL PY 40 sheet, can be substituted, in any of the two-layer membranes provided for the indicated uses, to the sheets of Type LBM-30, for being an improvement of benefits, increase of mass. The finishing sheet will be **LBM / 40-G**.

- Non-passable roofs, only accessible to maintenance professionals, installations, etc.
- According to "CEC" solutions, Flat roofs of type: 4.1.6
- According to UNE Standard 104401: 2013, type membrane, BA- NT.

Conditions of the "Non-passable flat roofs with light protection".

The conditions and the application are equivalent to those of covers with heavy protection, except for the exceptions:

- the membrane must always be adhered to the support. (A "non-adhered" solution is not acceptable)

SLOPING ROOF.- (Slopes between 15% and 40%)

Sloping roofs with light protection.

POLITABER POL PY 40 sheet is not recommended for this use. In any case

	POLITABER POL PY 40
	ELASTOMER MODIFIED BITUMEN SHEET. LBM (SBS). ELASTOMERIC SHEET
	TECHNICAL FILE Nº 32155 - REVIEW 8/16 C€ FECHA 16/04/2018

Sloping roofs, with discontinuous elements. Heavy protection or not.

They are the covers designed to evacuate the water with the help of the slope and finished with discontinuous elements of coverage (tiles, light alloy plates, slate or bituminous plate – Tegola Americana).

POLITABER POL PY 40 sheet is recommended only in case of monolayer membrane under: roof tile or other discontinuous covering. With battens, inverted cover, etc. Also under Tegola Americana, bituminous plate. (Not recommended with ceramic tiles placed directly over the sheet, possibility of sliding).

- **NOT PASSABLE roofs**, with tiles or other discontinuous element protection, on battens, etc. According “CEC” solutions. Roof type: 4.1.9, 4.1.11 and 4.1.12
According to UNE 104401: 2013, norm, sheet type, MC-TE, MI-TE and BC-PB.

Support conditions in “Sloping roofs”.

As a base support of the waterproofing sheet, concrete, cement mortar, wood or ceramic board, thermal insulation boards, etc. can be used. If the base support plates are thermal insulation, shall be resistant to welding sheets, or to apply a protective layer, for example a layer of mortar, this being reinforced.

The waterproofing sheet be mechanically attached or adhered to the support. In adhered systems, previously apply a primer, **SUPERMUL** type or similar. A single and very light layer will apply. It does not apply when using welded insulation boards, **LAROC S**.

In the case of an inverted roof, insulation boards shall be extruded polystyrene, XPS, **ChovAFOAM 300**. The finish of the panels will be smooth upper surface, with tiles on battens, or grooved finish with mortared tiles.

If you step on the membrane, on the movements, you should take the necessary safety measures to prevent falls.

Sloping roof way of placement

It will be carried as provided in flat roof, with the following conditions:

- The sheet rows are placed in the slope direction;
- The application starts, preferably from the edge corresponding to prevailing winds;
- The sheet must always be adhered;
- For slopes between 15% and 40% also will fix mechanically in the transverse overlaps and the distance between adjacent fastener will be 30 cm high, and will be located approximately at half the width of the overlap band and 4 cm at least the edge of the sheet

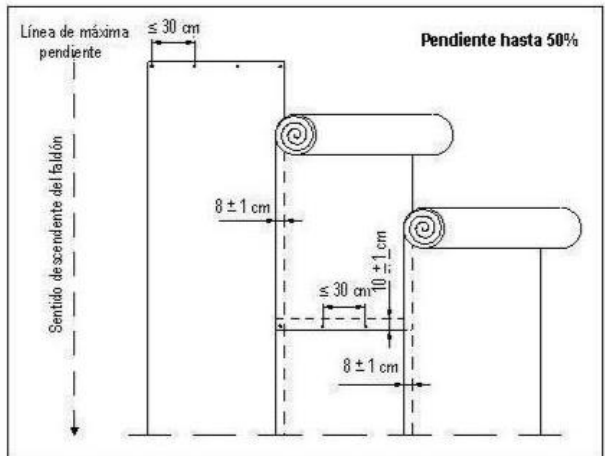
<p>Single layer sheet.</p> <p>Slope between 15 % and 40 %.</p> <p>A layer of sheets making overlaps should be placed between them. Longitudinal overlaps shall have a nominal width 8 ± 1 cm. Mechanical fixings in the transverse overlap. (See Figure)</p>	
---	--

	POLITABER POL PY 40
	ELASTOMER MODIFIED BITUMEN SHEET. LBM (SBS). ELASTOMERIC SHEET
	TECHNICAL FILE Nº 32155 - REVIEW 8/16 C€ FECHA 16/04/2018

It must also be considered:

- at the ridge and overlaps, in addition to adhering, the sheet must be fixed mechanically;
- when the upper end of the sheet lift a facing, it must also be fixed mechanically;
- between the nail and the edge of the sheet must be a distance of 4 cm or more.
- the attachments must penetrate the resistant support 15 mm, at least depending on its nature and consistency.

Overlaps adherence will be performed welding by heating. A review will be done, by heating the overlap edge and sealing it with the trowel.

WALLS AND FOUNDATIONS

Treatment in walls and foundations has some requirements depending on the ground groundwater level and the depth of the foundation. Check conditions and requirements.

POLITABER POL PY 40 sheet is recommended as single layer sheet or bilayer constituent, for improvement, where provided. Depending on the groundwater level, regarding the foundation.

The sheet application to form the membrane was adjusted to casuistry flat roof, in foundations, and sloping roof, - it really is in the vertical- in walls. In this case sheets shall be applied in the bottom-up direction and always adhered. (In addition, in general, No mechanical fastening is required).

For considerable height walls, in application conditions, always prevail safety requirements at work, at the expense of applying smaller size pieces compared to the full rolls application. But, ensuring good adhesion to the wall and the effective overlaps sealing.

Always, if in doubt, consult in advance with the Technical Department **ChovA, S. A**

GENERAL. COMPLETION SHEET WORK.

- On the roof, keep the rolls standing, to implementation, in the original pallet, not stacking pallets on top of other.
- Waterproofing work should not be performed when weather conditions may be harmful, especially when it is snowing or there is snow or ice on the roof, when its raining or the roof is wet, or when strong winds blow. Neither work should be performed when the ambient temperature is less than:
 - a) + 5 ° C when water-based emulsions are used;
 - b) - 5 ° C when modified bitumen sheets are used.
- It should have a flat without ridges, clean and dry properly uniform surface.
- You always have to make the sealing of the membrane at the end of the day, and especially if rain threatens.
- A tightness test shall do once finished membrane. It was recommend:
 - Flat roof, root flood for at least 24 h. and at most about 48 hours. (In case of rain risk, the test should be postponed to avoid overloads on the cover).
 - In sloped roof, irrigation cover for at least 48 h and a maximum of about 72 h.
- Flashings should be placed before applying the protection, on the expansion joint. If it's raised, they should be protected adequately.
- The store of protective materials, should be done in response to avoid damaging the sheet, and distributed avoiding overloads. No objects shall deposit over the membrane, such as drums, planks, pickaxes, shovels, etc., which may deteriorate
- During the application, shall be avoided perform actions on the sheet that may damage it, such as cutting tile, insulation panels, etc., taking necessary precautions if necessary.
- The protection elements must be placed with joints between them, to allow the passage of water and the free expansion of materials.
- Do not apply sheet products not compatible, e.g. projected polyurethane.
- We should make a subsequent maintenance of the deck, in the periods specified in the legislation or in the CTE.

SECURITY CONDITIONS.

	<p>POLITABER POL PY 40</p>
	<p>ELASTOMER MODIFIED BITUMEN SHEET. LBM (SBS). ELASTOMERIC SHEET</p>
	<p>TECHNICAL FILE Nº 32155 - REVIEW 8/16 C€ FECHA 16/04/2018</p>

Regarding the safety and health during the execution of the works, shall apply the provisions of legislation in relation to the Prevention of Occupational Risks.

Personnel performing the waterproofing system should know the risks involved in its implementation and the correct method of placing the roof units, all within the overall regulatory framework for health and safety that is required the general contractor of the work.

All the solutions above indicated, the conditions of application and comments are set to:

- DR CTE, CEC, "**Constructive Elements Catalog**" and
- UNE 104401: 2013, "**Waterproofing in the above and below ground building, with modified bituminous sheets. Systems and application.**"(AENOR Document)
- DIT Nº 578R/15: "**POLITABER ZERO SLOPE**".

The bituminous sheet is a component of the waterproofing membrane. Waterproofing solutions are the responsibility of the project, although the included information is intended to describe the usual conditions of product use. As for commissioning work, also must satisfy the requirements of waterproofing implementing specified in the rules. The information provided is taken from the current regulations.